

Grafikmagazin

Advertising rates list no. 06
effective from 1 January 2026.

Media pack 2026

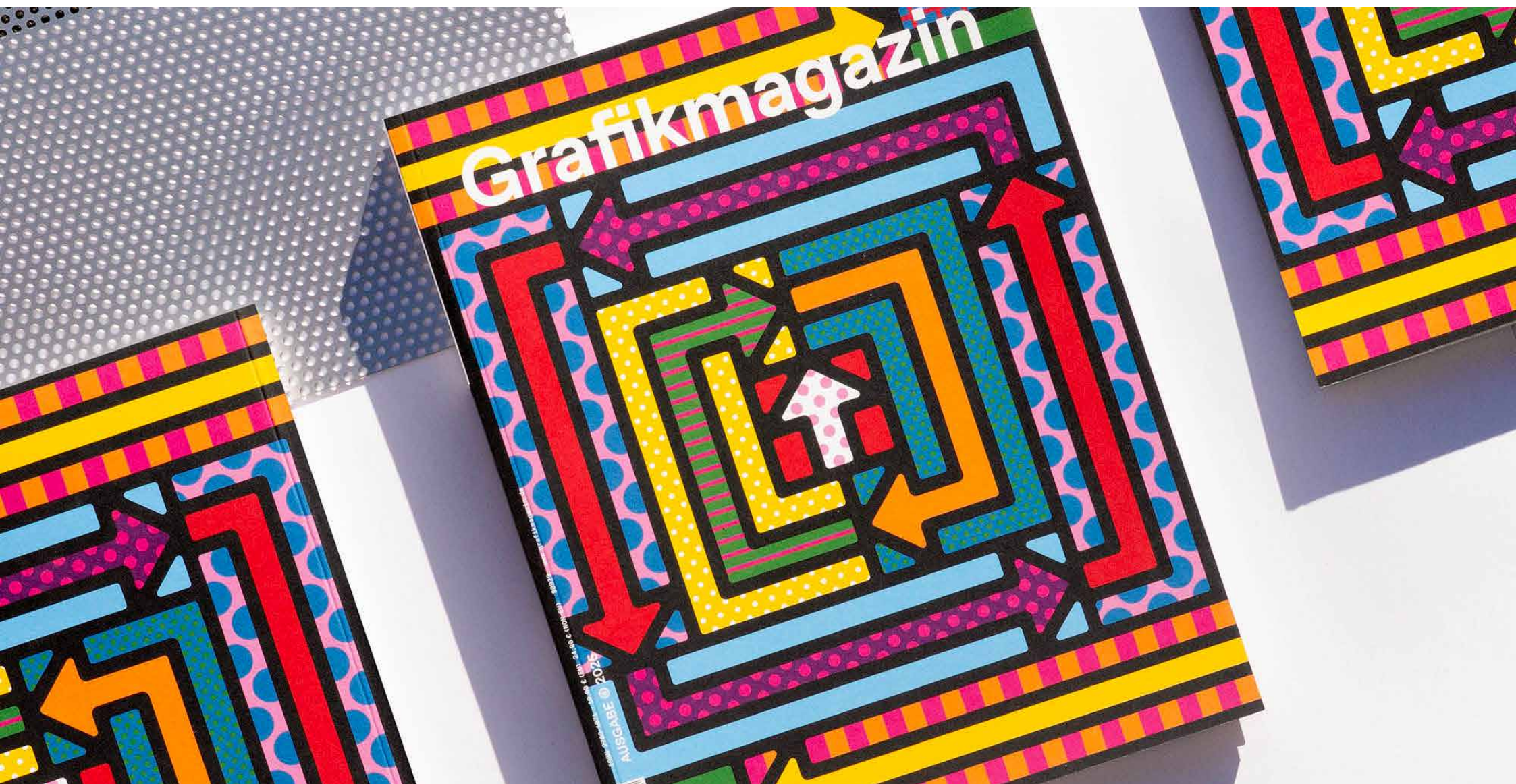

Grafikmagazin is the specialist magazine for communication design, aimed primarily at professional graphic designers, creative agencies and design students. As well as ideas, inspiration and design innovations, **Grafikmagazin** also features the kind of practical information and background designers need for success.

The magazine explores in six issues per year exciting portfolios and design projects that offer top-quality creative solutions. Typography plays an important part of each issue, so, too, in-depth topic sections on, for example, setting up a design studio, or on aspects of sustainability. In the »Design & Research« section we look at new design approaches, experimental formats and design theory, as well as the work of emerging design talents.

As a print edition and online, and with a range of interesting additional offers, **Grafikmagazin** is aiming to be a reliable and valuable partner to our readers, presenting them with professional journalism and first-class design.

It's the medium that makes the difference. Including for your message!

Test it for yourself – use **Grafikmagazin** as a platform for attracting attention to your products and company.

Grafikmagazin is a perfect platform for you to reach out intelligently and successfully to a top-flight audience of professional creatives.

Your contact at **Grafikmagazin** for advertising:

Christian Meier
meier@grafikmagazin.de
T: 089-215364255



We present every two months the best in contemporary graphic design, illustration, photo design, online design, corporate design, advertising and typography.

Every issue the **Grafik+** section takes a close look at a different field of design. With its focus on individual themes, e.g. corporate communication, typography, information design, poster design etc., **Grafikmagazin** is a treasure chest of ideas and inspiration, a valuable and highly collectible resource.

Photographic projects also have a place in **Grafikmagazin** – given special treatment on art paper.

Another change of paper ushers in the section on **Production & Publishing**, a 16-page feature reporting in detail on remarkable print projects, and providing the readers with a wealth of information on choice of paper, print and finishing options and production.

In the **Design & Research** section we look at new design approaches, experimental formats and design theory, as well as the work of emerging design talents.

Dates & Features 2026

01.26

Grafik+ design for museums

Distribution date: 12. February 2026

Booking deadline: 16. January 2026

Copy deadline: 20. January 2026

03.26

Grafik+ Branding Tech. Comp.

Distribution date: 11. June 2026

Booking deadline: 13. May 2026

Copy deadline: 15. May 2026

05.26

Grafik+ corporate illustrations

Distribution date: 03. December 2026

Booking deadline: 06. November 2026

Copy deadline: 10. November 2026

02.26

Grafik+ artificial intelligence

Distribution date: 16. April 2023

Booking deadline: 18. March 2023

Copy deadline: 20. March 2023

04.26

Grafik+ mailings & invitations

Distribution date: 01. October 2026

Booking deadline: 04. September 2026

Copy deadline: 08. September 2026

Advertising: Ad Formats

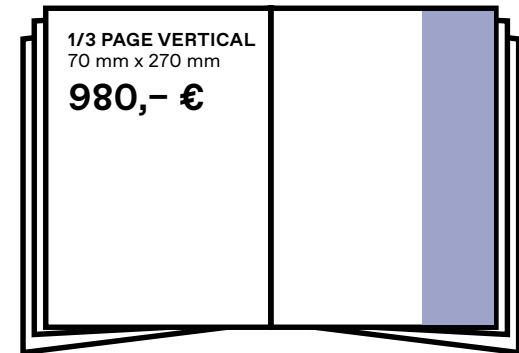
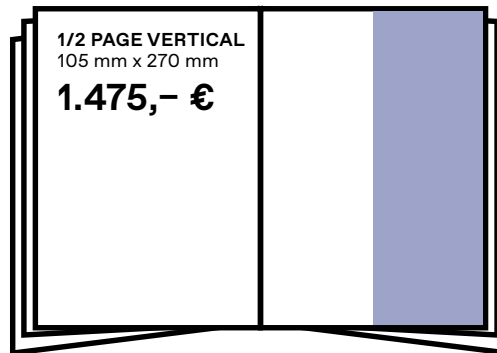
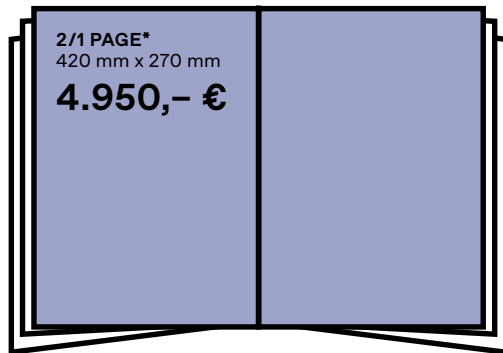
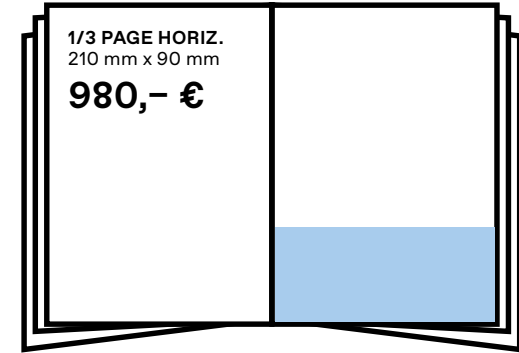
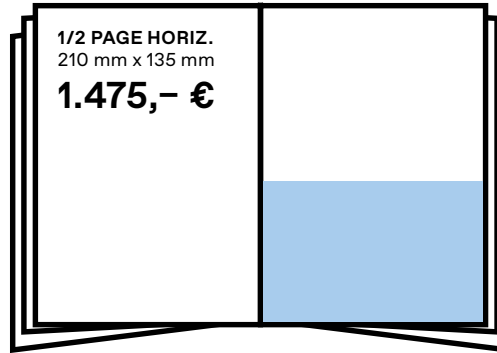
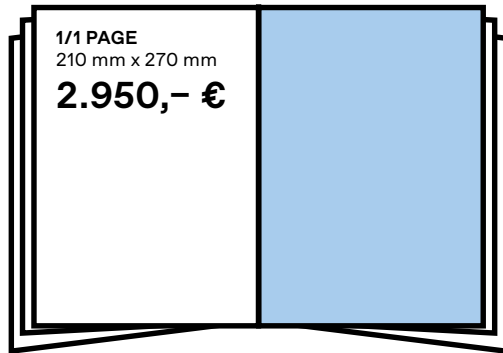

Bleeds – 3 mm trim allowance all around for full page ads.

Advertising: Ads on the Cover

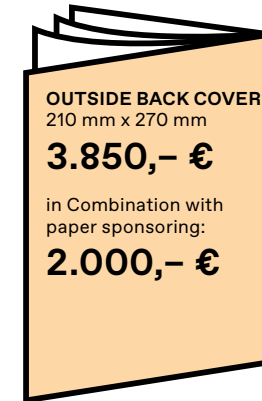
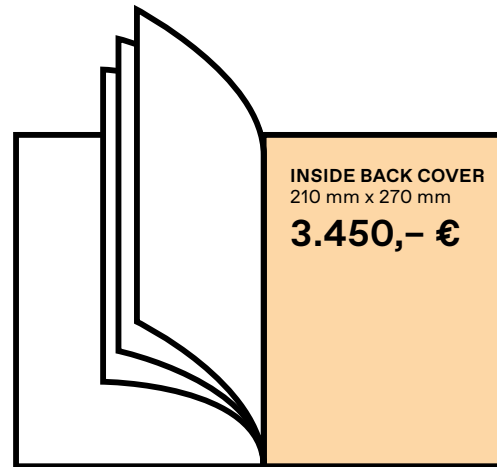
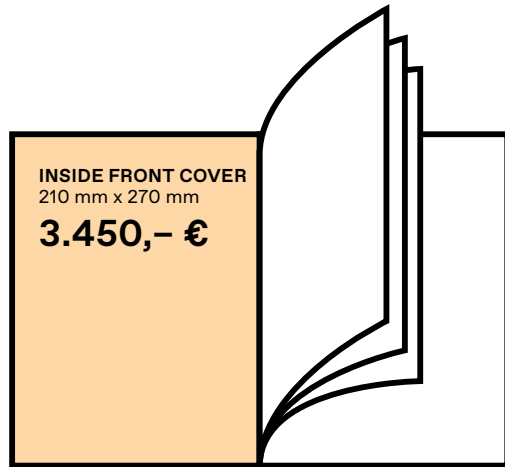

Bleeds – **3 mm** trim allowance all around
for full page ads.

Reductions*

for frequency

3 ads 5 %
6 ads 10 %

*for ads placed within
one year

for volume

3 pages 3,0 %
5 pages 5,0 %
6 pages 6,0 %
10 pages 10,0 %
12 pages 15,0 %

For job advertisements we give a 30% discount.

Advertising: Inserts

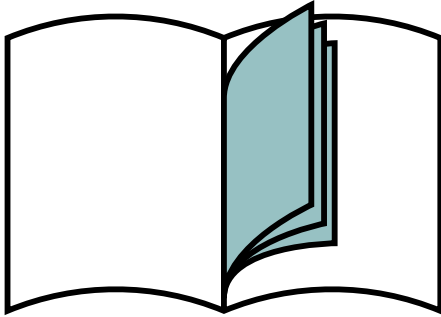
**Bound inserts**

1 to 2 sheets per thousand

Price: €285

Allow 5mm bleed on the head and 3mm on the other sides of the page. 4-page bound inserts must be delivered folded. Final sample inserts requested in advance. Prices for special types of ads such as spreads or cover flaps, upon request.

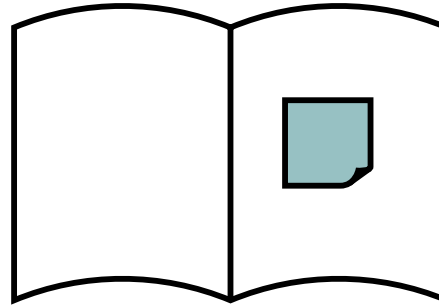
**Tip-on cards**

(only in connection with a full page ad)

Postcards or response-cards

per thousand €120

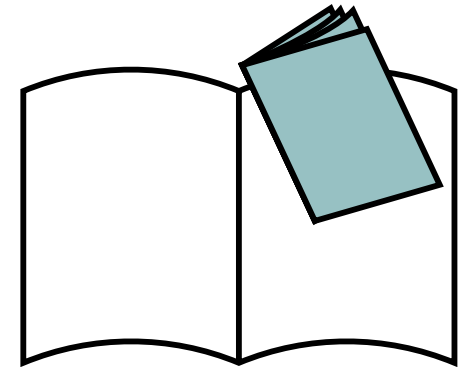
**Loose inserts**

Sizes up to 200 mm x 260 mm

up to 25 g
per thousand €265
 for each additional 5 g
 per thousand €10

*Selective distribution is also possible
 prices on request.*

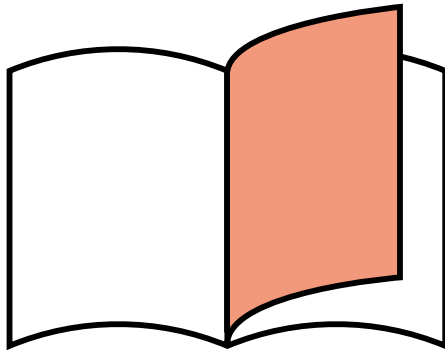

Personalised page 3 for your customers.

Are you looking for something special to surprise your customers with? How about a personalised issue of **Grafikmagazin**? Here's how it works: We add an extra page to **Grafikmagazin**, bound into the magazine before the editorial, and your photos and personalised letter to your customers appear in our layout on that page. The back of that page is available for your own full-page advert. After the magazines have been printed, we send you a package containing the number of issues you ordered, and you can then give these personalised **Grafikmagazin** magazines to your customers. Alternatively, for a very reasonable fee, we can send them direct to your customers on your behalf.

Price for personalisation of **50 magazines:**
€378 (Complete price: €628 including the individual issues)

Price for personalisation of **50 magazines,**
incl. despatch to individual recipients:
€528 (Complete price: €778 including the individual issues)

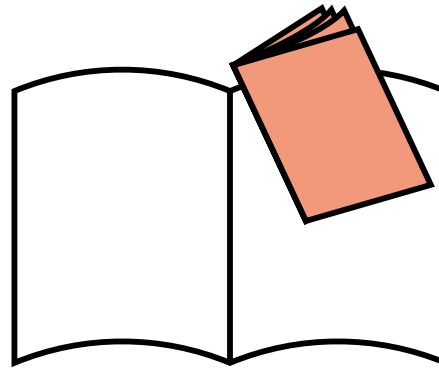

Get Grafikmagazin to produce your inserts for you

You can save time and delivery costs by having your bound or loose inserts produced direct by **Grafikmagazin**. That way you benefit from our paper and printing expertise.

Price, incl. printing and inclusion in novum:
 Insert, 1 sheet/2 pages (300 g image print, matt or glossy) from PDF.

Price: **2.850 Euro**

We would be happy to draw up an individual quote for producing an insert for you (incl. text and design). Just call us.

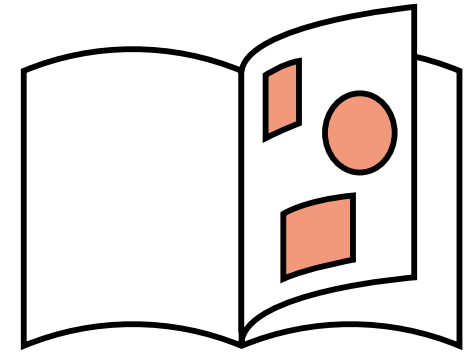

Content Creation

Would you like to place the design of your **Grafikmagazin** advert in the professional hands of our graphics department? No problem. You deliver the content and we design your content in an individual design or in the look and feel of **Grafikmagazin**. Including a free revision round.

Price in addition to the advertising costs: **€ 650**

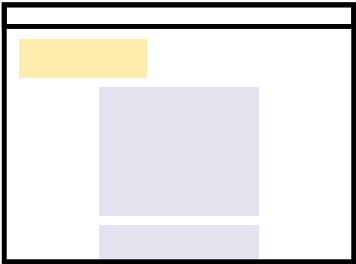

Display Ads/Banner

Leaderboard 970 × 250px

€420 per week

Content Ad 300 × 250px

€200 per week

Place static or interactive banners on our attractive website (JPEG, Flash or GIF, HTML script). The minimum term is one week.

The advertisements can be managed via our own ad server including statistical analysis. The prices refer to permanent presence during the booking period.

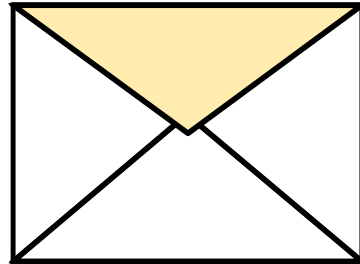

Newsletter

Ad per issue

Price: €1,250

The newsletter is published monthly and adverts are the first entry immediately after the contents list. Your advert can be up to 600 characters (without spaces) in length and it can contain one image (970px x 250px). Each newsletter contains only one ad. After distribution, a statistical analysis is made available to you.

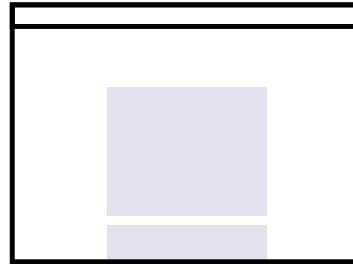

Native Advertising

Price: €1,250

Present your content as a »Sponsored Article« in the news section of our website. This very successful »Native advertising offer« has been very well received by creatives. We will create an online article in the look & feel of the **Grafikmagazin** website from your text, images, links and videos. We will also support the online article by providing the content on our social media sites.

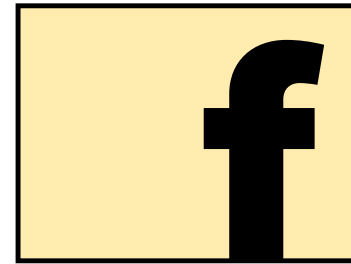

Social Media

Are you interested in special social-media-activities or web specials in connection with **Grafikmagazin**? If so, call us. We would be happy to advise and show you successful projects.

Easily address our **followers** with your message.

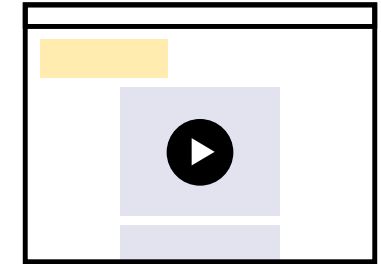

Direct Video Ad

Price: €250 per week

Present your company video/tutorial or making-of directly on our website. Users can view the video clip directly on the homepage. We only need your Youtube / Vimeo link or your video file.

Would you like to use a different format or a special web technique? Do not hesitate to contact us.

Published by

Phoenix Verlag für Grafikdesign
UG
Dachauer Strasse 114 B24
D-80636 München
Germany
T: +49 89-215364250

Managing director
Christian Meier

Advertisements

Phoenix Verlag für Grafikdesign
Dachauer Strasse 114 B24
D-80636 München
Germany

Contact:
Christian Meier
meier@grafikmagazin.de
T: +49 89-215364255

Editorial Office

Redaktion Grafikmagazin
Phoenix Verlag für Grafikdesign
Dachauer Strasse 114 B24
D-80636 München
Germany
T: +49 89-215364251

redaktion@grafikmagazin.de
www.grafikmagazin.de

—

Christine Moosmann
Editor-in-Chief
moosmann@grafikmagazin.de
T: 49 89-215364252

—

Sonja Pham
Editor
pham@grafikmagazin.de
T: 49 89-215364253

—

Tobias Holzmann
Art Director
holzmann@grafikmagazin.de
T: 49 89-215364254

Circulation

Q 4/2023
Print run: 4.000

Frequency: 6 times a year

Magazine prices 2025

Single issue domestic: 19,80,- €

Annual subscription (print + ePaper): €105
Annual subscription ePaper: €65

Annual subscription international:
(print + ePaper) €125

Student subscription (print + ePaper): €75
Student subscription ePaper: €45

Student subscription international:
(print + ePaper) €105

Bank account

Commerzbank AG
Phoenix Verlag für Grafikdesign UG
IBAN: DE 91 7004 0041 0410 2232 00
BIC: COBADEFFXXX

VAT: DE 338 789 142

Invoices are payable in full within 30 days of invoice date.

**(all prices include postage)*

File format**File format**

Printable PDF file formats (PDF/X-4) are preferred Printing profile: ISOcoated_v2 For colour matching on the printing press, a colour proof is imperative. For open files we accept no liability.

Image data

Colour images: CMYK-TIF or -EPS, uncompressed, resolution 300 dpi
Lines: Bitmap-TIF, resolution 1,200 dpi
b/w images: grey-tone TIF or EPS, uncompressed, resolution 300 dpi

Technical guidelines**Transmission of material**

Grafikmagazin can accept no liability for imperfect processing or publication of digitally transmitted data if the above-mentioned technical guidelines are not adhered to.

Address for delivery of bound and loose material

F&W Druck- und Mediencenter
Herr Kronast
Holzhauser Feld 2
D-83361 Kienberg
Germany
T: +49-8628 98 84-33

Please mark the envelope:
»For **Grafikmagazin** issue
(month.year)«

Address for delivery of advertising material

Phoenix Verlag für Grafikdesign
Dachauer Strasse 114 B24
D-80636 München
Germany

Contact:
Christian Meier
meier@grafikmagazin.de
T: 089-215364255

